

Adjustable Carbon Attenuators

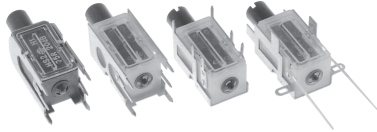

FEATURES

- Model M2001H is for matching the characteristic impedance of coaxial antenna cables and is suitable for antenna amplifiers of up to 900MHz.

MECHANICAL SPECIFICATIONS

- Casing:** Plastic material, dust protected.
Shielded Basket/Pins: Electroplated SN, 5 μ .
Mounting: Fish-plates.
Adjustment: Insulated plastic shaft with screwdriver slot and .079 inch [2mm] hexagon.
Terminals: Silver plated lugs, tinned pins.
Nominal angle of rotation: 3 (+ 3.0 - 0.5) revolutions. 6 revolutions on request.
Operating torque: .56 to 1.96 oz. in.
End stop torque: 4.97 oz. in. (7 Ncm). Fixed stop at 3 revolutions. 6 revolutions, clutch mechanism, no end stop.
Weight: .13 to .14 oz.

MATERIAL SPECIFICATIONS

- Cover:** Makrolon 94V2.
Shaft: Durethan 94V0.
Case: Hostaform 94HB.

STANDARD ELECTRICAL SPECIFICATIONS

Resistive Element	Carbon on laminated paper
Wiper Contact	Metal
Impedance	75 ohms, 50 ohms (60 ohms on request)
Power Rating	.25 watt
Nominal Attenuation and Tolerance	20dB (+ 5 - 2dB), 10dB (+ 2 - 2dB), 6dB on request
Adjustable Minimum Attenuation	≤ 0.5 dB
Variation in Attenuation Due to Frequency	
up to 300MHz	≤ 0.25 dB
over 300 to 900MHZ	≤ 1 dB
Reflexion Attenuation	.5 to 20dB attenuation
up to 300MHz	≥ 20 dB
up to 900MHz	≥ 15 dB
Temperature Limits	- 25°C to + 70°C

NOTE: Typical curves for transmission and return loss available.

DIMENSIONAL CONFIGURATIONS [in millimeters]

M2001HP1

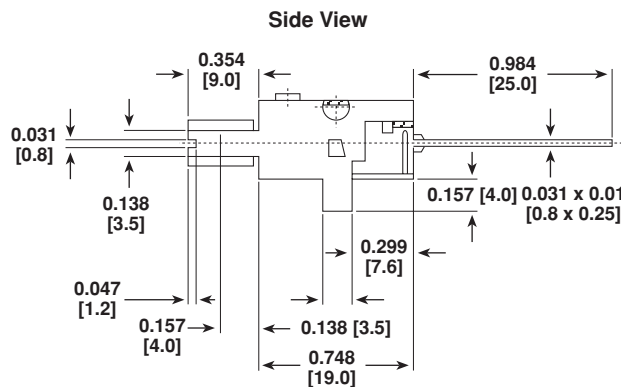

End View (All Versions)

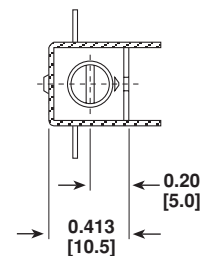

Top View

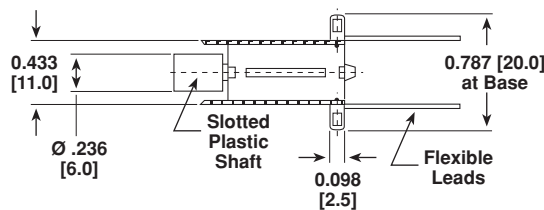

Electrical Circuit

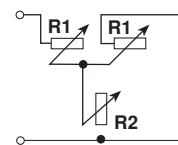

DIMENSIONAL CONFIGURATIONS [in millimeters]

M2001HP2

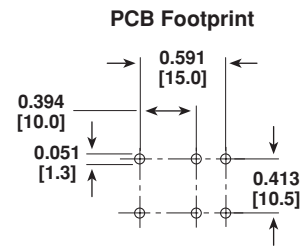
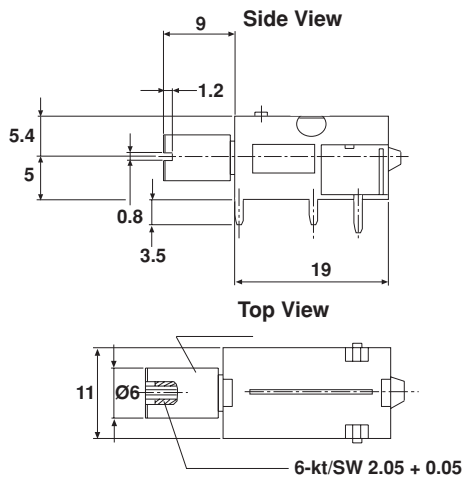

Electrical Circuit

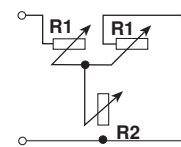

M2001HS2

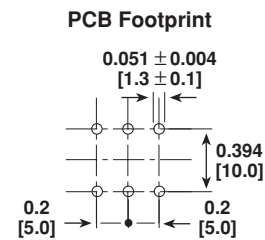
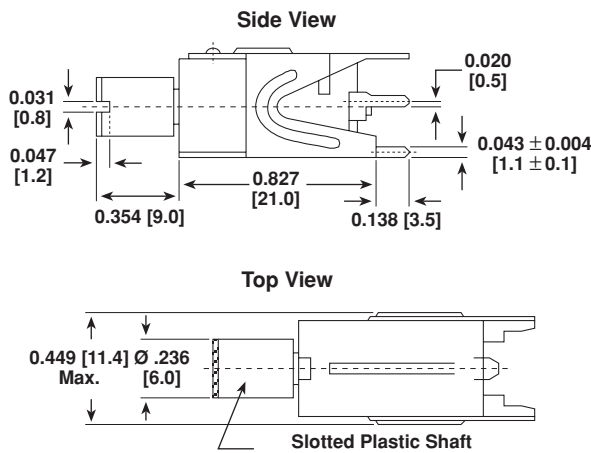

Electrical Circuit

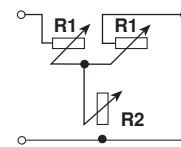

M2001HP3

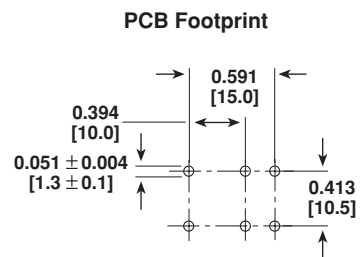
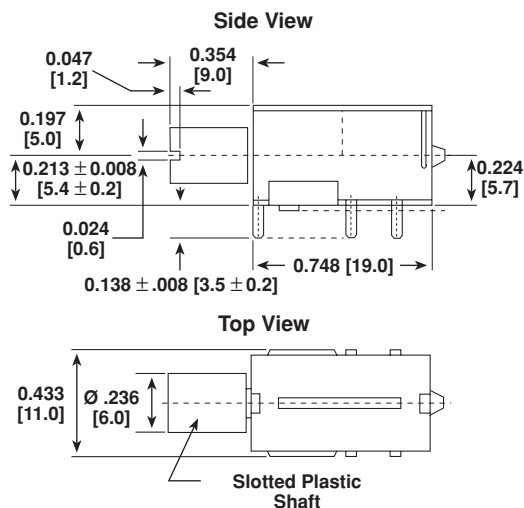

Electrical Circuit

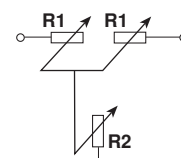



PACKAGING

M2001HP1, M2001HS2: 250 pieces in bulk.
M2001HP2, M2001HP3: 100 pieces in plastic insert.

HOW TO ORDER

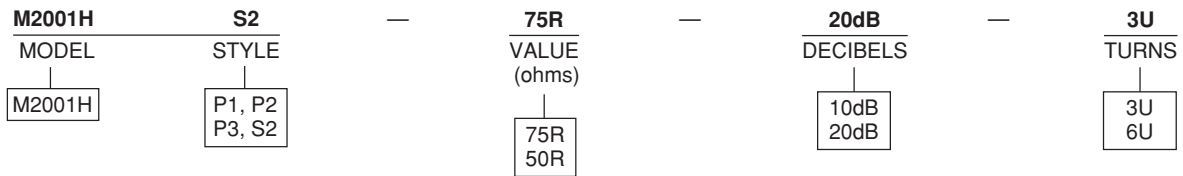



Notice

Specifications of the products displayed herein are subject to change without notice. Vishay Intertechnology, Inc., or anyone on its behalf, assumes no responsibility or liability for any errors or inaccuracies.

Information contained herein is intended to provide a product description only. No license, express or implied, by estoppel or otherwise, to any intellectual property rights is granted by this document. Except as provided in Vishay's terms and conditions of sale for such products, Vishay assumes no liability whatsoever, and disclaims any express or implied warranty, relating to sale and/or use of Vishay products including liability or warranties relating to fitness for a particular purpose, merchantability, or infringement of any patent, copyright, or other intellectual property right.

The products shown herein are not designed for use in medical, life-saving, or life-sustaining applications. Customers using or selling these products for use in such applications do so at their own risk and agree to fully indemnify Vishay for any damages resulting from such improper use or sale.